



**Your trusted global partner
in life-saving research.**

For over 50 years, Allentown has provided critical solutions to the biomedical research community. Our high-quality equipment and advanced vivarium systems continue to define and exceed industry standards. Like everything we do, our unparalleled customer service is stamped with the Allentown hallmarks of integrity, dedication and care.

NexGen™

RAT COMBO



OVERVIEW

Providing critical solutions with integrity and care.



NexGen Rat Combo

The lightest, most cost-effective, easiest-to-use animal-friendly IVC system in the LAS industry, now configured for combination rat housing with both Rat 900 and 1800 caging.

Smooth sliding, easy gliding cage docking / undocking
(Validated by third-party ergonomist)

Low vibration spares animals and staff from discomfort

Reduced need to move animals or clean out cages

Observation made easier and faster

“Super easy to take cage out of rack”

“It’s so quiet I can barely hear it”

“The functionality and manoeuvrability alone are excellent”

“All the animals bred well”

“Blower is simple to operate with no vibration issues”

COMPONENTS



IVC System

- Positive or negative precision air controlled rack
- Exhaust plenum always negative to the room
- 15 and 30 cage capacities available
- Whole rack system and cages are autoclavable up to 134 °C¹ and chemically sterilisable
- Plastic (polysulfone) cage support runners with integrated spring-operated cage lock with docking indicator
- Ergonomic, single-finger motion docking with auto-locking feature
- Multi-directional 127 mm diameter stainless steel casters with gray polypropylene wheels with sealed ball bearings and four foot-operated brakes
- Dismantable horizontal airflow manifolds with tethered dual plastic end caps for ease of cleaning
- Rear exhaust and supply plenum configurations for single-sided IVCs, or same side exhaust and supply plenum configurations for double-sided IVCs
- 100 mm diameter vertical supply and 100 mm diameter vertical exhaust plenums with back and bottom door access
- 304 stainless steel, welded frame construction, utilizing both square and rectangular structural tubing
- Cage air tubes are 304 stainless steel
- Automatic watering available
- Row and column identification labels
- Model number and serial number identification labels
- Compatible with all configurations of EcoFlo™ blowers
- Compatible with WiVarium Plus™ and Wi-Com Vantage™
- Compatible with Sentinel™ EAD® colony health monitoring system
- Compatible with Wi-Com Sensus™ RFID census solution

Cage System

- Cage floor space of 1800 cm² (Rat 1800) and 916 cm² (Rat 900)
- Cage height of 254 mm (Rat 1800), plus multiple enrichment options, permits bipedal posture and animal enrichment
- Unobstructed views into and out of cage
- Wider, more ergonomic design (Rat 1800) for balanced weight distribution during handling
- Ergonomic handles on side of cage (Rat 1800) for ease of handling
- Clear polysulfone plastic
- Gasketed cage lid ensures safety and protection from damage
- Clear cage and flip-up / stay-up cardholders improve observations
- Easily accessible water bottles (EBT)
- Hinged filter retainer swings up for easy filter replacements
- Compact nesting and stacking for more efficient autoclaving throughput
- Available with or without locks and with multiple feeder configurations

SPECIFICATIONS

Size	Depth (A)	Width (B)	Height ¹ (C)	Height ^{1,2} (D)	Matrix		Sides	Weights ³ (loaded)	Weights ³ (unloaded)	Animal Capacity	ACH	Supply Air	Exhaust Air (+)	Exhaust Air (-)	Energy Use	Heat Load
	mm	mm	mm	mm	Col.	Row		kg	kg			m ³ /hr	m ³ /hr	m ³ /hr	Watts	Watts
127 mm Casters																
15	622	1594	1697	1726	3	5	1	170	83	40	60	30.6	23.8	39.1	13.2	11.8
30	889	1700	1697	1726	3	5	2	266	131	80	60	57.8	44.2	73.1	14.4	13.0

Note: a.) Airflow at sea-level. b.) Rack weight without blowers, animals, bedding or watering. c.) Airflow tolerance ± 10%. d.) Other configurations available.
¹ Height includes casters. Add 247 mm to 297 mm for rack mounted blowers. ² Height includes removable runners and collars. ³ All weights are approximations.

Notes

Ergonomic handles on side of cage for ease of handling

127 mm diameter casters

Optional top panel

Optional bumpers may change dimensions

Multiple blower configurations

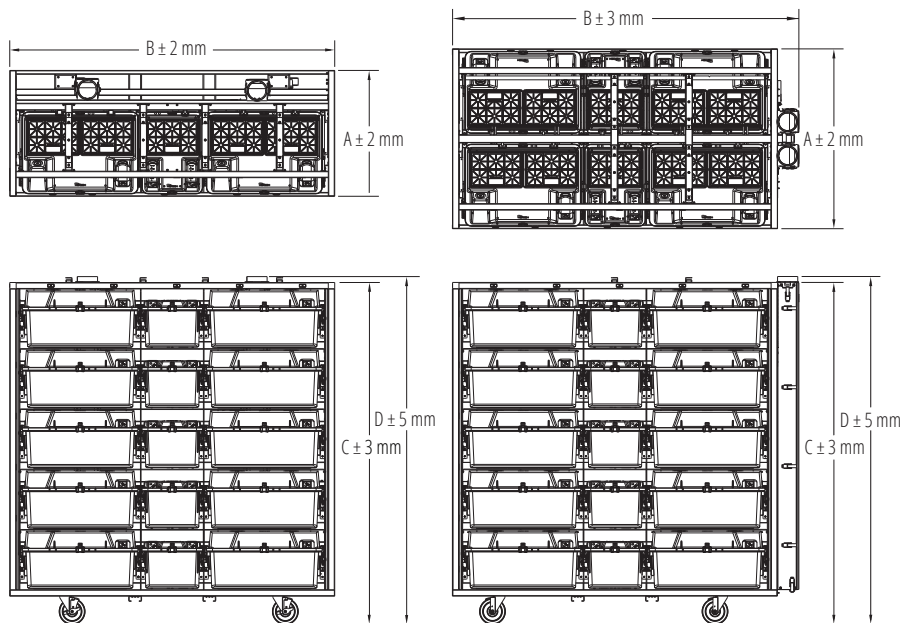

COMPONENTS – RAT 900

Cage System with External Bottle Top
300 mm x 234 mm x 412 mm
Floor space: 916 cm²

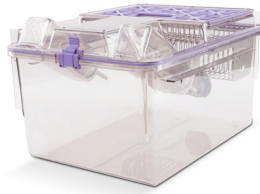

Cage System with Micro Barrier Top
300 mm x 234 mm x 412 mm
Floor space: 916 cm²

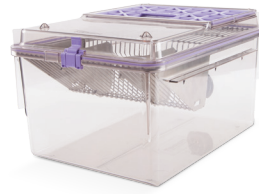

Bottle



250 mL | 281 g (filled)
Item # PC250BCL+SLC



350 mL | 395 g (filled)
Item # PC350BCL+SLC

Top



External Bottle Top
300 mm x 115 mm x 410 mm | 885 g
Item # 225440-1 (without locks)
Item # 225440-2 (with locks)



Micro Barrier Top
300 mm x 49 mm x 412 mm | 748 g
Item # 225556-1 (without locks)
Item # 225556-2 (with locks)

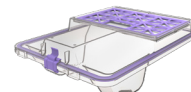

External Hydropac® Top*
300 mm x 127 mm x 410 mm | 907 g
Item # 229382-1 (without locks)
Item # 229382-1 (with locks)

Cardholder



76 mm x 102 mm Vertical
Item # VH34P9-8
(also available in 76 mm x 127 mm
Item # VH35P9-8)



76 mm x 102 mm Horizontal
Item # HH34P9-8
(also available in 76 mm x 127 mm
Item # HH35P9-8)

WBL / Feeder

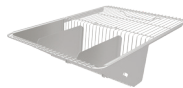

Wire Bar Lid
Food capacity: 771 g
283 mm x 99 mm x 388 mm | 726 g
Item # 412417



Half Pocket Wire Bar Lid
Food capacity: 998 g
283 mm x 122 mm x 216 mm | 454 g
Item # 412410

Enrichment



Cage Divider
245 mm x 277 mm x 373 mm | 249 g
Item # 228543



Enrichment Loft
189 mm x 106 mm x 90 mm | 136 g
Item # 315584

Cage



Cage
300 mm x 195 mm x 395 mm | 1225 g
Item # 225720-1 (without automatic watering)
Item # 225720-2 (with automatic watering)

SPECIFICATIONS – RAT 900

External Dimensions

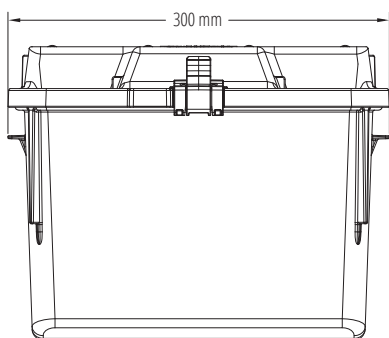
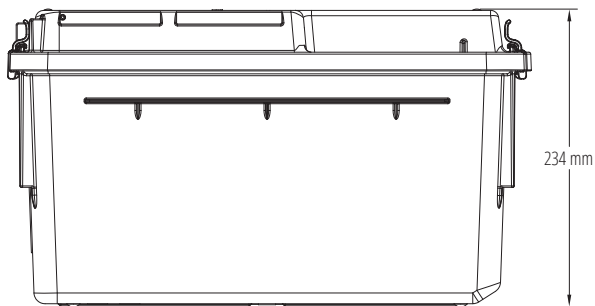
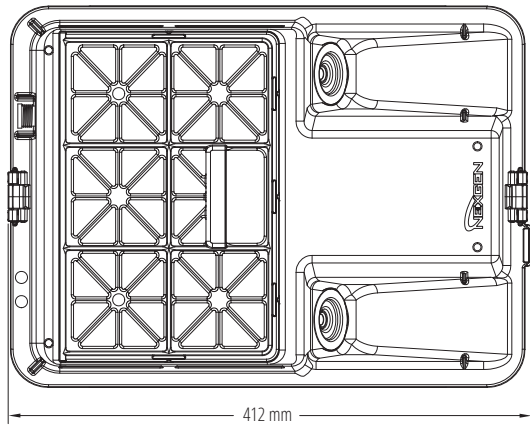

Internal Dimensions

Full Pocket

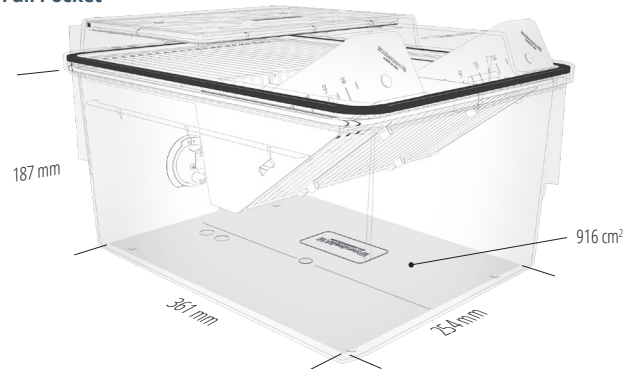

Half Pocket

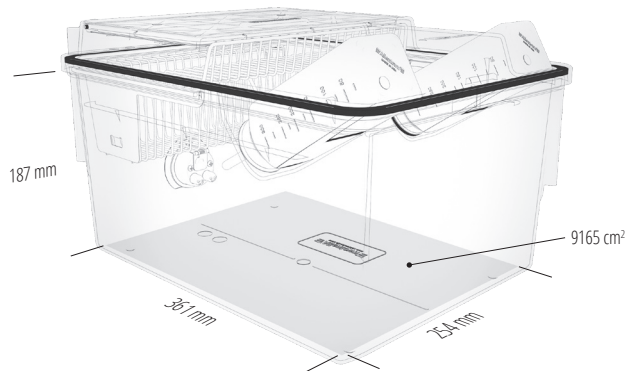

SPECIFICATIONS – RAT 900

External Bottle Top

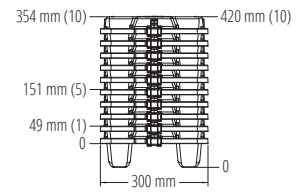
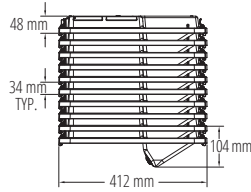
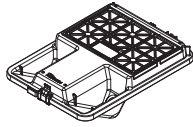

Micro Barrier Top

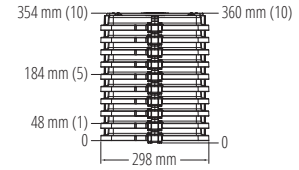
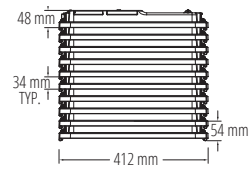
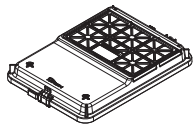

External Hydropac Top

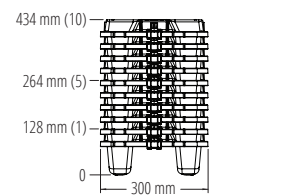
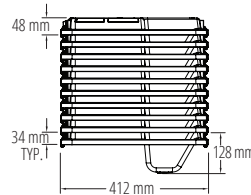
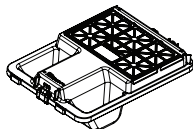

Full Pocket Wire Bar Lid

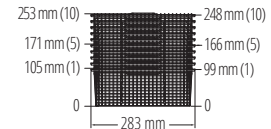
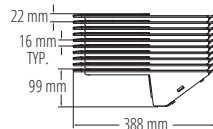

Half Pocket Wire Bar Lid

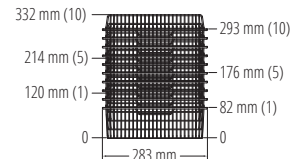
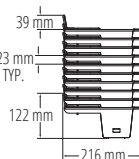

Cage

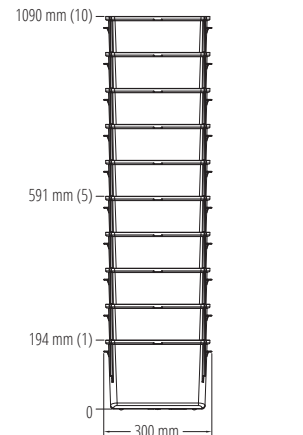
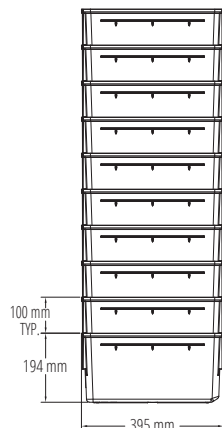
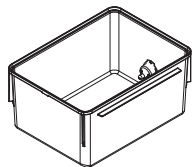

COMPONENTS – RAT 1800

Cage System with Wire Bar Lid and Front Loft
588 mm x 412 mm x 286 mm
Floor space: 1800 cm²



Cage System with Rear Shelf and Enrichment Loft
588 mm x 412 mm x 286 mm
Floor space: 1800 cm²

Bottle



350 mL | 395 g (filled)
Item # PC350BCL+SLC



450 mL | 508 g (filled)
Item # PC450BCL+SLC

Top

External Bottle Top
Optional Filter Guard available
572 mm x 171 mm x 410 mm | 1860 g
Item # 230347-1 (without locks)
Item # 230347-2 (with locks)



Cardholder

76 mm x 102 mm Vertical
Item # VH34P9-8
(also available in 76 mm x 127 mm
Item # VH35P9-8)



76 mm x 102 mm Horizontal
Item # HH34P9-8
(also available in 76 mm x 127 mm
Item # HH35P9-8)



WBL / Feeder



Wire Bar Lid
Food capacity: 998 g
553 mm x 170 mm x 388 mm
1633 g | Item #: 413126



Chew Guard
Food capacity: 998 g
553 mm x 174 mm x 386 mm
1633 g | Item #: 414194



Hanging Feeder: Rat
Food capacity: 1202 g
140 mm x 186 mm x 124 mm
454 g | Item #: 228934



Hanging Feeder: Guinea Pig
Food capacity: 998 g
89 mm x 183 mm x 140 mm
381 g | Item #: 228542



Hanging Feeder: Guinea Pig/Ferret
Food capacity: 1202 g
129 mm x 185 mm x 107 mm
653 g | Item #: 228560

Enrichment



Cage Divider
514 mm x 258 mm x 371 mm
748 g | Item #: 227078-1



Enrichment Loft
189 mm x 106 mm x 90 mm
136 g | Item #: 315584



Front Loft
150 mm x 8 mm x 89 mm
68 g | Item #: 227356



Rear Shelf (WBL Attachment)
538 mm x 13 mm x 138 mm
476 g | Item #: 227694



Rear Shelf (Stand Alone)
552 mm x 18 mm x 387 mm
862 g | Item #: 227429

Cage

Cage
588 mm x 194 mm x 395 mm | 2449 g
Item # 226231-1 (without automatic watering)
Item # 226231-2 (with automatic watering)



SPECIFICATIONS – RAT 1800

External Dimensions

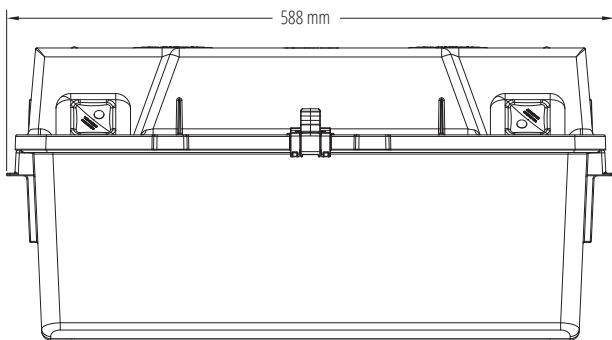
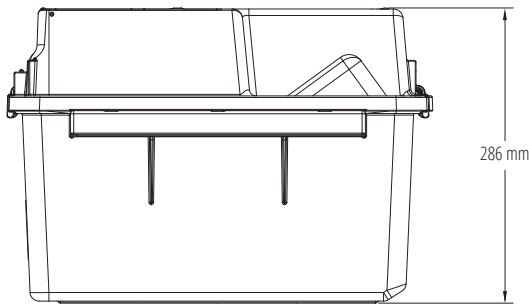
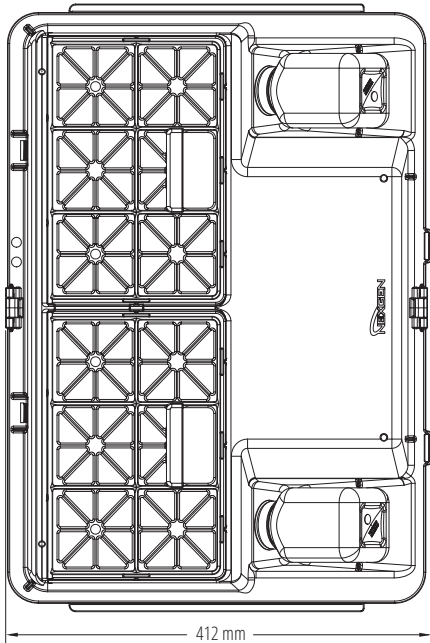

Internal Dimensions

Full Pocket

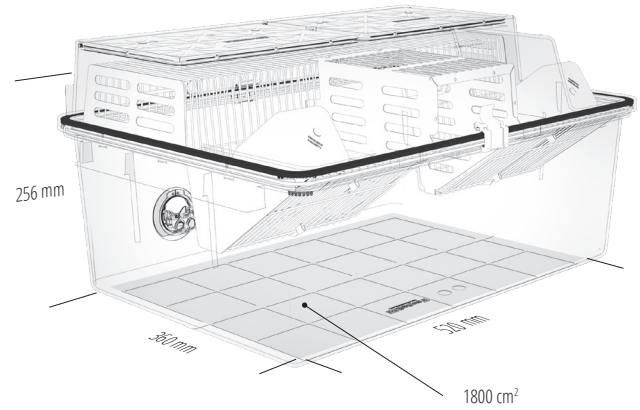

Chew Guard

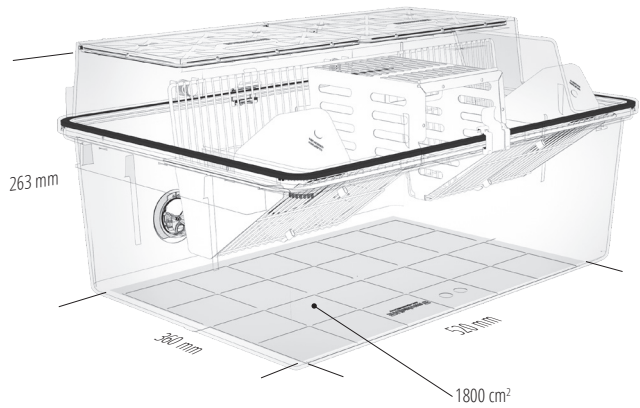

SPECIFICATIONS – RAT 1800

External Bottle Top

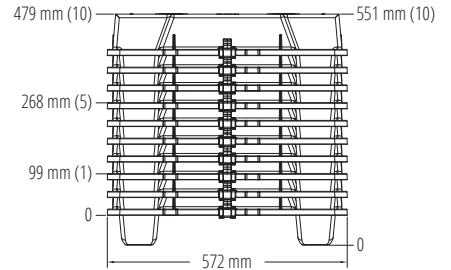
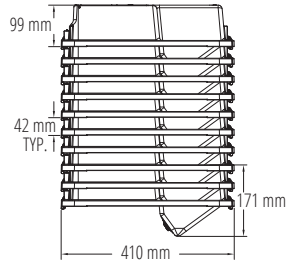
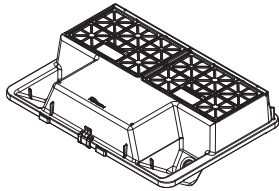

Full Pocket Wire Bar Lid

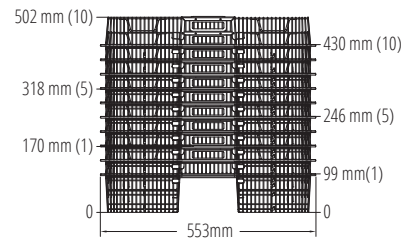
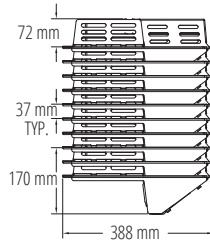
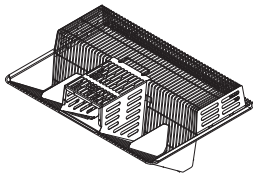

Chew Guard

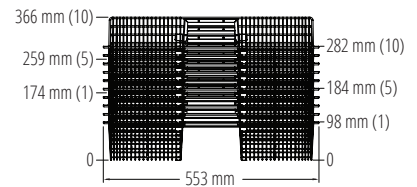
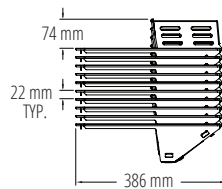
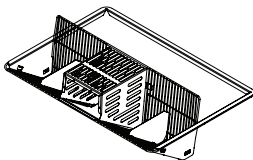

Cage

